

Tender No:
KDUSC/PRO/RP & SERVICE/011/2021

M/S.....
.....
.....



General Sir John Kotelawala Defence University,
Southern campus, Edison Hills,
Nugegalayaya, Sewanagala, Sri Lanka.
Adjutant 0473624894
Procurement Officer 0473624893
Fax 0473620811
www.kdu.ac.lk

23 March 2021

INVITATION TO BID AND GENERAL CONDITIONS OF TENDER

1. The Rector of the General Sir John Kotelawala Defence University – Southern Campus, as the Chairman, Department Procurement Committee invites Bid/s from prospective Bidders for supply of **items listed and specifications of the items are indicated in Annex "A"**.

2. **CLOSING DATE & TIME.** The tender will close at 1000 hrs on 06/04/2021. Any Bid submitted after the closing time of the tender will be rejected & unopened such bids will be returned to the bidder.

3. **VALIDITY OF BID.** The bid submitted under this tender **must be valid for a period of 120 days from the date of closing of tender.**

4. **VALUE ADDED TAX.** The Bidders who bid for locally delivered items must have the VAT registration. The VAT portion must be shown separately in the price schedule in Annex "A" and VAT registration number must be indicated. If the quoted item is exempted from VAT or Bidding Company is not liable for VAT, reference number and date of relevant Act number/Gazette notification/a certificate (as applicable) **issued for the current financial year** from the Commissioner General of Inland Revenue to that effect should be submitted along with the Bid.

5. **BID SUBMISSION.** The **bidder must duly sign at the last page (before Annexes) of this document** indicating the name of the signatory and the name of the company & place the company common seal to confirm the acceptance of tender conditions. **The Bid/s that do not include authorized signature will be rejected.** The Bid/s duly signed by the bidder enclosed and sealed in an appropriate cover addressed to the following address should be sent by registered post or could be deposited in the **appropriate tender box placed at General Sir John Kotelawala Defence University- Southern Campus, Edison Hills, Nugegalayaya, Sewanagala.** (at the Main Entrance of General Sir John Kotelawala Defence University) on or before the time & date specified for the closing of tender. **The tender reference number, date & time of closing tender should be indicated & underlined at the top left corner of the envelop.**

6. **BID OPENING.** All duly received bids **will be opened immediately after the scheduled closing time of Bids at the same venue.** Bidders or their accredited agents could be present at the time of opening of bids.

7. **PRICES.** For locally delivered items (including locally manufactured items & foreign items imported by the bidders) price must be quoted in Sri Lankan Rupees, inclusive of all charges for delivery of items to General Sir John Kotelawala Defence University- Southern Campus stores at Sewanagala. **Unit price, VAT and Total price should be clearly indicated in schedule in Annex "A"**.

8. **DELIVERY.** Preference will be given for early delivery. In case of bulk supplies for locally manufactured items, the delivery of **total quantity must be completed within 120 days of signing of contract,** unless mutually agreed for extended delivery period with General Sir John Kotelawala Defence University. **The bidder/s must indicate the proposed delivery schedule in Annex "E"**. In the event of placing a purchase order with the successful bidder, the total quantity so ordered must be supplied as one consignment unless part deliveries are agreed upon in the contract. The deliveries not made as per agreed delivery schedule will be considered as bad performances by the suppliers and **no extended delivery period will be authorized.**

9. **PAYMENT TERMS FOR LOCALLY DELIVERED ITEMS.** Payment will be made after acceptance of items which should be subjected to a pre-acceptance inspection/testing by General Sir John Kotelawala Defence University authorities. Any item that does not confirm to the specifications or already approved sample will be rejected & it is the responsibility of the supplier to remove them from General Sir John Kotelawala Defence University stores/premises within 07 working days of such intimation (either verbal or written) at his own cost and replace them with items conforming to specification within one month of such rejection.

10. **Special Instruction SAMPLES/PAYMENT OF TESTING CHARGES.**

When it is required to submit samples, **every offer** must be accompanied with pre - marked samples. The marking of samples **indicating the Bidder & Offer number** must be done and the samples must be handed over to the officer at same place where tender box is placed **on or before the closing date & time of the Bid.** Samples submitted after closing time of the Bid will be rejected. When the testing charges are required to be paid, bidders shall pay testing charges separately **for all offers** indicated in their bid/s.

- (i) **Samples.** Please submit..... Samples.
(ii) **Testing Charges.** A sum of Rs. **per offer** must be paid to the Assistant Bursar of KDU, prior to the submission of bid and a copy of the receipt must be annexed to the bid. It is the responsibility of bidder to inform the Cashier of the Account Office to note the tender number on the receipt issued for such payments.

SR/ NO	Description	Denomination of Qty	Qty Required	Country/ Brand Or Origin	Unit Price	Total Price
	FABRICATING & FIXING OF ALUMINUM PARTITION WORKS IN PROPOSED RENOVATION IN OFFICERS' MESS - SOUTHERN CAMPUS					
1.0	Material & System					
	All aluminum work to be Natural Anodized locally extruded aluminium profile. A detail submission of catalogues and the data fully describing system and thickness of all glass panels to be specified as recommended by the manufacturers.		Note			
	Construction					
	The installation shall be according to the specifications of the manufacturer's proprietary assembly details.		Note			
	All dimensions are to be verified at site before fabrication commences		Note			
	Partition Wall A					
1.1	Supply and fixing of Aluminium composite panel for 5375mm x 3150mm overall size wall fixed on Aluminium frame with all necessary accessories, joints shall be covered with black color silicon sealant, all as per the drawing and client specifications.	Item	1			
	Partition Wall B					
1.2	Supply and fixing of Aluminium composite panel for wall fixed on Aluminium frame with all necessary accessories, joints shall be covered with black color silicon sealant, rate shall include provisions for light fittings, all as per the drawing and client specifications.	Item	1			
	Door					
1.3	Supply and fixing of 6 mm thick float glass, Aluminium framed 2 nr sash swing door, size 1200 mm x 2100 mm overall comprising frame with mat black powder coat, all necessary accessories, all as per the drawing and client specifications.	Nr	2			
	(Drawings and specifications are attached as annexes)					
	Note:					
	Tax: (If Any)					
	VAT: (08%)					
	Grand Total:					
	Warranty:					
	Make Model & Country					
	* Please Indicate The Unit Price After All Possible Discount					
	* Past experiences are to be mentioned					

- I. Validity of Offer
- II. Delivery Period
- III. Credit Period
- IV. Discount if any
- V. Ex- Stock availability

.....
Signature of Authorized Officer

Name:.....

T/Phone No:.....

E mail :

Registration No:.....

.....
Rubber Stamp of the Firm

75X50 POWDER COATED ALUMINIUM FRAME

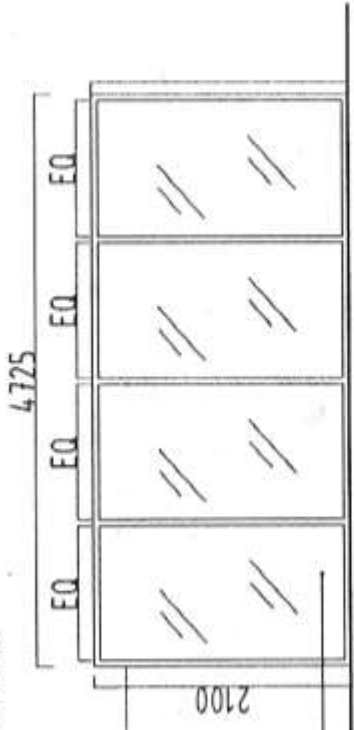

PARTITION WALL "B"
ELEVATION A

A 6MM THICK COLOURED FLOAT GLASS

PARTITION WALL "B"
PLAN

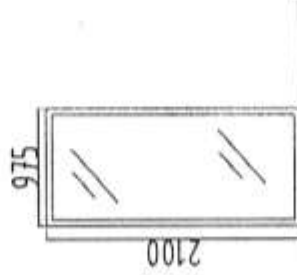

PARTITION WALL "B"
ELEVATION B

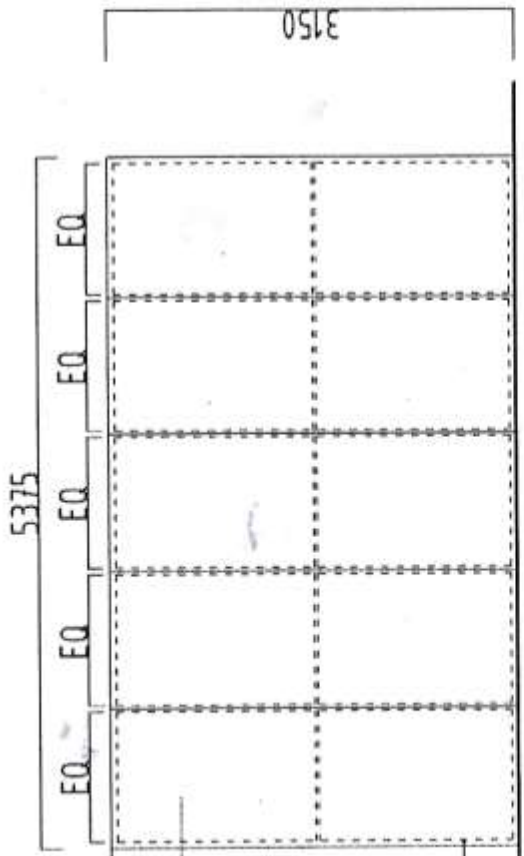

BEAM BOTTOM

ALUMINIUM
COMPOSITE PANEL
PARTITION WALL "A"

PARTITION WALL "A"
ELEVATION

METAL FRAMEWORK

CUSTOMIZED DISH RACK

+600 GROUND FLOOR

D4a

SECTION B - B

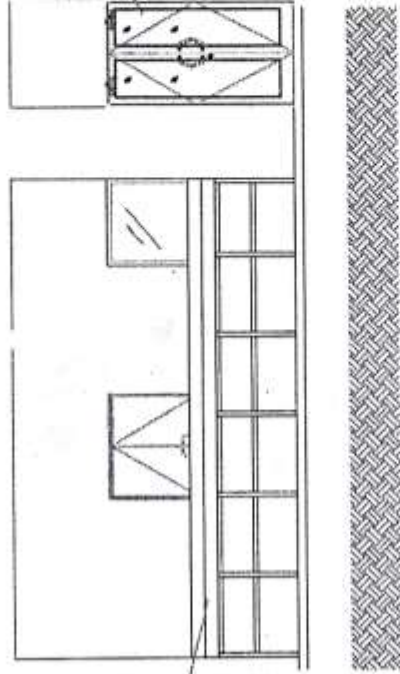

D4a

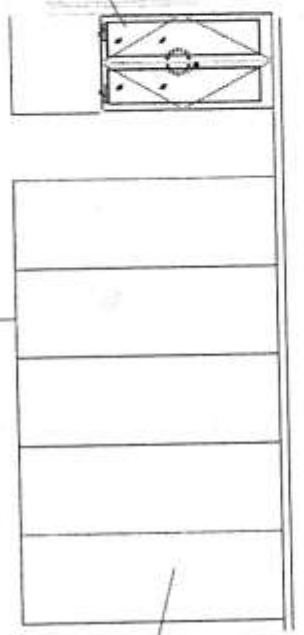

ALUMINIUM COMPOSITE PANEL
PARTITION WALL "A"



+600 GROUND FLOOR

SECTION A - A

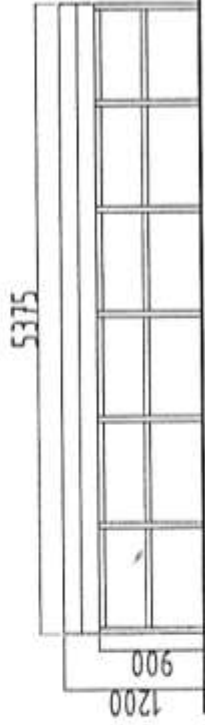

DISH RACK

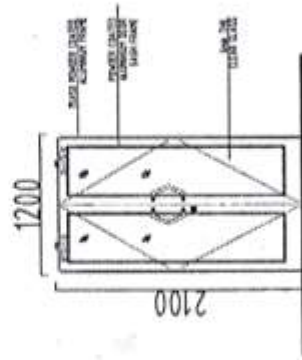

ELEVATION D4a

